

# SPA Series

## Switching mode power supply with minimized noise and ripple

### ■ Features

- Built-in overcurrent protection, output short-circuit protection, overheating and overvoltage protection circuits(SPA-075/100)
- Standard on safety IEC 60950, IEC 50178
- EMS(Electromagnetic susceptibility) EN61000-6-2
- EMI(Electromagnetic interference) EN61000-6-4
- Output voltage : 5VDC, 12VDC, 24VDC
- Output current : 30W, 50W, 75W, 100W



⚠ Please read "Caution for your safety" in operation manual before using.

**CE**  
(except 5VDC)

### ■ Ordering information

<b>SPA</b>	—	<b>030</b>	—	<b>24</b>	
				Output voltage	05 5VDC
					12 12VDC
					24 24VDC
			Output power		030 30W
					050 50W
					075 75W
					100 100W
Item					SPA Switching Mode Power Supply

### ■ Specifications

Model	SPA-030-05	SPA-050-05	SPA-030-12	SPA-050-12	SPA-030-24	SPA-050-24	SPA-075-05	SPA-100-05	SPA-075-12	SPA-100-12	SPA-075-24	SPA-100-24		
Capacity	30W	50W	30W	50W	30W	50W	75W	100W	75W	100W	75W	100W		
Power supply <sup>※5</sup>	100-240VAC(85-264VAC)						100-120/200-240VAC(85-132/170-264VAC) switching type							
Input	50/60Hz													
Efficiency <sup>※1</sup>	Min. 60%	Min. 67%	Min. 74%		Min. 80%		Min. 70%		Min. 78%	Min. 72%	Min. 78%	Min. 80%		
Current consumption <sup>※1</sup>	Max. 1.2A	Max. 1.6A	Max. 1.0A	Max. 1.4A	Max. 0.8A	Max. 1.1A	Max. 3.0A		Max. 2.0A	Max. 3.0A	Max. 2.0A	Max. 2.5A		
Output	Voltage		12VDC		24VDC		5VDC		12VDC		24VDC			
	Current		6A	10A	2.5A	4.2A	1.5A	2.1A	15A	20A	6.3A	8.5A	3.2A	4.2A
	Voltage adjustment range <sup>※4</sup>		±5%											
	Input fluctuation ratio <sup>※2</sup>		Max. ±0.5%											
	Load fluctuation ratio <sup>※1</sup>		Max. ±2%		Max. ±1%		Max. ±2%		Max. ±1%					
	Ripple <sup>※1</sup>		Max. ±1%											
	Starting time <sup>※1</sup>		Max. 200ms				Max. 150ms		Max. 250ms					
	Holding time <sup>※1</sup>		Min. 10ms				Min. 5ms		Min. 10ms	Min. 5ms	Min. 10ms	Min. 10ms		
Protection	Inrush current protection		Max. 30A(100VAC) Max. 40A(200VAC)		Max. 20A(100VAC)		Max. 45A(100VAC) /Max. 50A(240VAC)		Max. 35A(100VAC) /Max. 40A(240VAC)	Max. 45A(100VAC) /Max. 50A(240VAC)	Max. 35A(100VAC) /Max. 40A(240VAC)	Max. 35A(100VAC) /Max. 40A(240VAC)		
	Output overcurrent protection <sup>※3</sup>		Min. 110%				Min. 105%		Min. 110%					
	Output overvoltage protection		—				6.5V ±10%		16V ±10%		30V ±10%			
	Output short-circuit protection		Max. 5ms				Max. 10ms		Max. 5ms	Min. 10ms	Max. 5ms			
Output indicator	Green LED													
Insulation resistance	Min. 100MΩ(between all input and output terminals with 500VDC)													
Dielectric strength	3.0kVAC 50/60Hz for 1 min. (between all input and output terminals)													
	1.5kVAC 50/60Hz for 1 min. (between all input terminals F.G)													
Vibration	0.75mm amplitude at frequency of 10 to 55Hz(for 1 min.) in each of X, Y, Z directions for 2 hours													
Shock	300m/s <sup>2</sup> (approx. 30G) in each of X, Y, Z directions for 3 times													
EMS	Conforms to EN61000-6-2													
EMI	Conforms to EN61000-6-4													
Protection	IEC60950, IEC50178 standard													
Environment	Ambien temperature		-10 to 50°C				-10 to 40°C		-10 to 50°C					
	Storage temperature		-25 to 65°C											
	Ambient humidity		25 to 85%RH, storage: 25 to 90%RH											
Approval	<b>CE</b> (except 5VDC)													
Unit weight	Approx. 350g						Approx. 400g							

※1: 100% load for rated input voltage(100VAC).

※2: Rated input voltage [ SPA-030/050 Series : 100-240VAC(85-264VAC) ] under 100% of load.

[ SPA-075/100 Series : 100-120/200-240(85-132/170-264VAC) ]

SPA-100-05 is under 100% of load for [100-120/200-240VAC(100-132/190-264VAC)].

※3: Rated input voltage(100VAC). ※4: Vary voltage by output voltage adjuster, it is changed over voltage variation range(±5%).

※5: The rated input volatge of SPA-100-05 is 100-120/200-240VAC(100-132/190-264VAC).

※Environment resistance is rated at no freezing or condensation.

# General Purpose Type Switching Mode Power Supply

## Output feature data for ambient temperature

### SPA-030-05

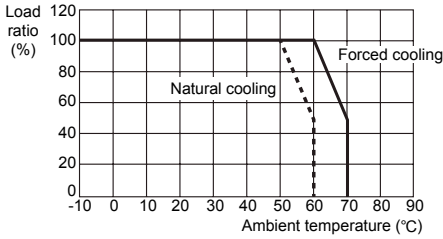

### SPA-075-05 • SPA-100-05 • SPA-100-12

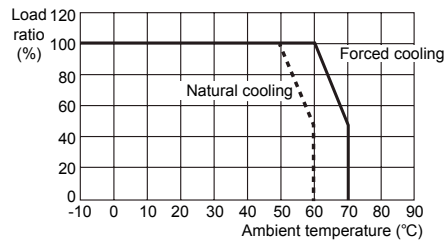

### SPA-030-12 • SPA-050-12

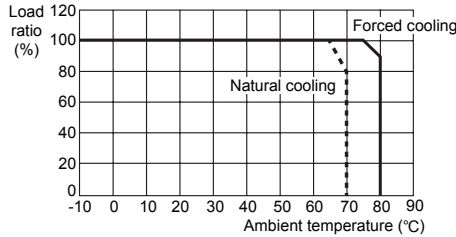

### SPA-075-12

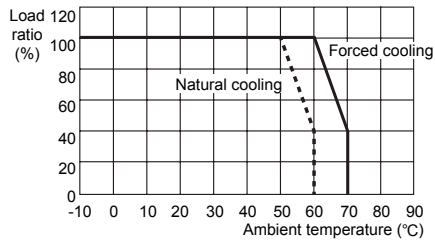

### SPA-030-24 • SPA-050-24

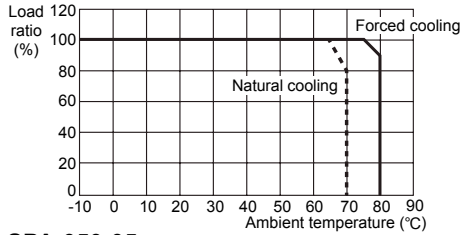

### SPA-075-24 • SPA-100-24

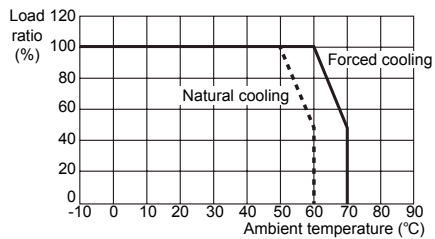

### SPA-050-05

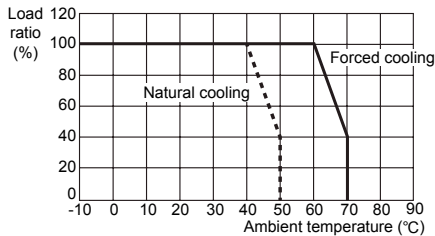

## Feature data for output overvoltage protection

### SPA-075-05 / SPA-100-05

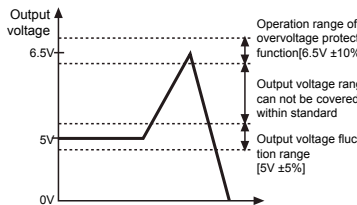

### SPA-075-12 / SPA-100-12

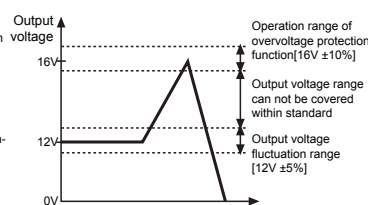

### SPA-075-24 / SPA-100-24

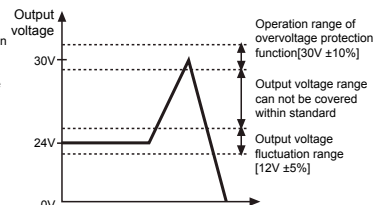

## Feature data of overcurrent protection

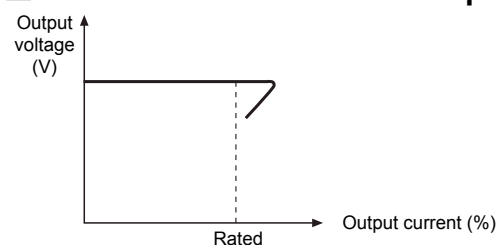

- It is when the rated input voltage is 100VAC, 100%.
- It is able to protect overcurrent by load with built-in overcurrent protection circuit.

When the over rated current is flowed, the circuit is operated (output voltage is fallen) and it is cancelled when the load current is under the rated current. (it is returned to the rated output voltage)

(A)	Photo electric sensor
(B)	Fiber optic sensor
(C)	Door/Area sensor
(D)	Proximity sensor
(E)	Pressure sensor
(F)	Rotary encoder
(G)	Connector/Socket
(H)	Temp. controller
(I)	SSR/ Power controller
(J)	Counter
(K)	Timer
(L)	Panel meter
(M)	Tacho/ Speed/ Pulse meter
(N)	Display unit
(O)	Sensor controller
(P)	Switching mode power supply
(Q)	Stepper motor& Driver&Controller
(R)	Graphic/ Logic panel
(S)	Field network device
(T)	Software
(U)	Other

# SPA Series

## Block diagram

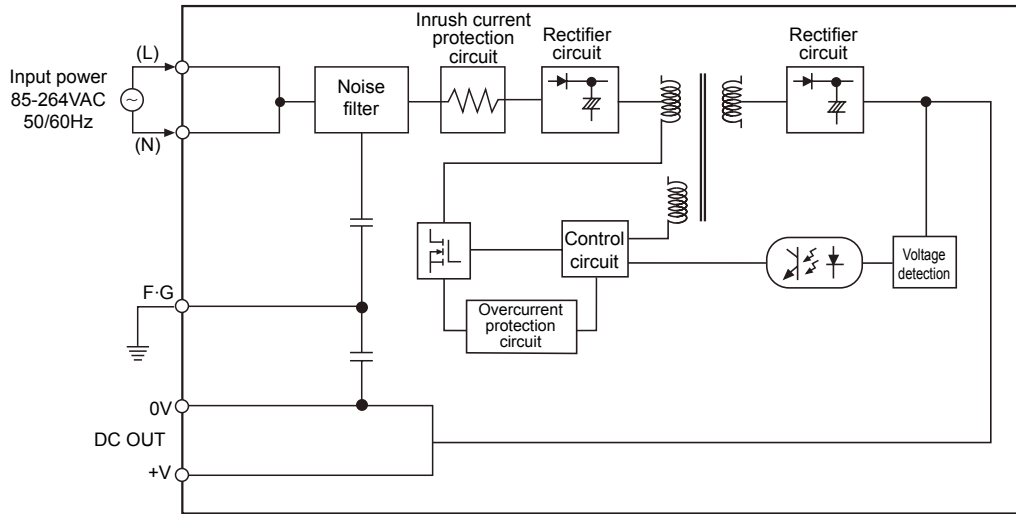

## Dimensions

(unit: mm)

### SPA-030/050 Series

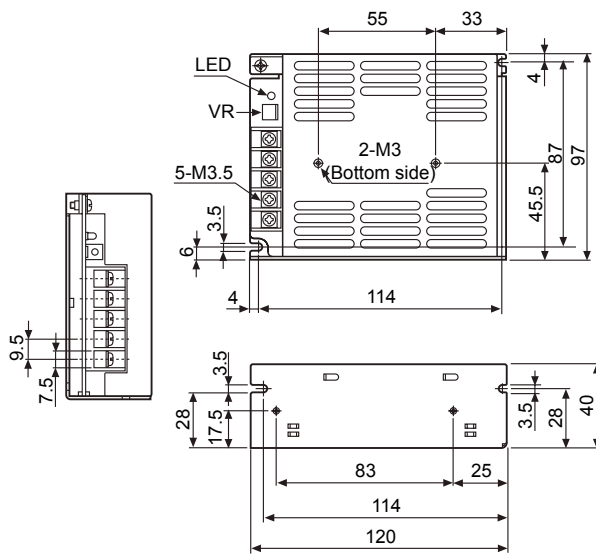

### SPA-075/100 Series

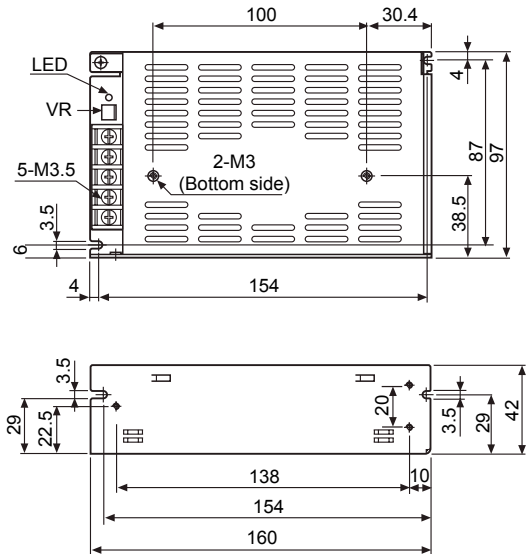

## Front part identification

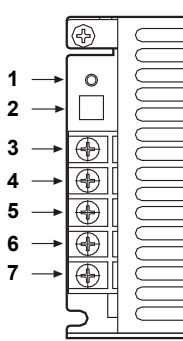

1. Output display LED(green)
2. Output voltage adjuster  
※V.ADJ(voltage variable range:  $\pm 5\%$  of the rated output voltage)
3. Output power [ + ] terminal
4. Output power [ - ] terminal
5. [ F.G ] terminal
6. Input power [ N ] terminal
7. Input power [ L ] terminal

# General Purpose Type Switching Mode Power Supply

## ■ Proper Usage

- For switch input voltage type, input voltage is 220V as factory default. To switch input voltage for 110V, remove the cover then select proper jumper switch as below figures.

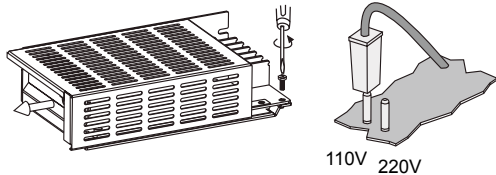

- Technical information of operation
- This product is not available to operate of output voltage as parallel and series.
- The output current should be used within the rated range. When it is operated in overcurrent status, the life span of product can be shortened.
- The output voltage should be used within the rated range. When the output overvoltage limit function is operated, the product operated normally with cancellation of input power for few minutes.
- The overvoltage limit function is operated when it is exceeded the rated output voltage range with an output voltage adjuster.
- This product has overheating protection function. It is operated normally when releasing the load connection for few minutes.
- The power factor is within 0.5 to 0.7 using condenser rectified method. Please use the below formula and check the input power capacity when using a cabinet panel or transformer.
 
$$\text{Apparent power[VA]} = \frac{\text{Active Power [W]}}{\text{Power factor} \times \text{Efficiency}}$$
- This product does not have harmonics suppression and power factor correction circuit. Please mount the device for it.
- This product has a noise filter, it can be changed with the mounting place and connection.
- Please change as a same rated fuse when the inner fuse is broken.

- Caution for mounting
- Please mount the device on metal panel for the reliability.
- Please mount the device in a ventilative place for high radiation of heat.
- Please use the power line as below specification.

Input power line specification	AWG19 to 21	AWG16 to 18
Model	SPA-030-05 SPA-030-12 SPA-050-12 SPA-075-12 SPA-030-24 SPA-050-24 SPA-075-24 SPA-100-24	SPA-050-05 SPA-075-05 SPA-100-05 SPA-100-12

(A) Photo electric sensor

(B) Fiber optic sensor

(C) Door/Area sensor

(D) Proximity sensor

(E) Pressure sensor

(F) Rotary encoder

(G) Connector/Socket

(H) Temp. controller

(I) SSR/Power controller

(J) Counter

(K) Timer

(L) Panel meter

(M) Tacho/Speed/ Pulse meter

(N) Display unit

(O) Sensor controller

(P) Switching mode power supply

(Q) Stepper motor& Driver&Controller

(R) Graphic/ Logic panel

(S) Field network device

(T) Software

(U) Other